

DMW143 ●

The Best of both worlds

Not only is the conventional version of the **SMZ-143-N2GG** the most wanted stereozoom microscope, but also it's digital version **DMW-143-N2GG** is a big hit. The zoom objective ensures high optical quality when observing a sample at 10X magnification, then zooming continuously to close-up details at 40X ... or any point in between.

With the **integrated multi-output camera**, the options are endless. Connect the microscope directly to the computer by using the UBS 2.0 cable and the included multi language **Motic Images Plus 2.0** software. But if you prefer to connect the microscope directly to a TV monitor via the S-Video cable or a direct connection to the projector with the RCA cable? It's also possible! Not only you can chose between one of the three outputs, **you can also use all there of them simultaneously!**

- Greenough zoom optical system
- Binocular head, 45° inclined with built-in analogue/digital camera CCD 1/3" chip
- 720x576 resolution USB2.0
- Max. 550 TV lines resolution S-Video & RCA
- Widefield eyepiece WF10X/20mm
- 4:1 Zoom ratio, WD=80mm
- Magnification range: 1X-4X
- N2GG: Base stand with pole and head holder
- Coarse focusing system with tension adjustment
- Intensity controlled halogen illumination incident 12V/15W and transmitted 12V/10W
- Switching power supply 100-240V (CE)
- Motic Images Plus 2.0 for PC and MAC
- USB, S-Video & RCA cables
- Calibration slide
- Black, white and frosted glass stage plates, blue filter and dust cover





Multi-Output ●

DMW-B1, DMW-143

Both the DMW-B1 and DMW-143 have digital and analogue connections, allowing you to **connect your microscope simultaneously to:**

Computer

TV monitor

Projector / Beamer

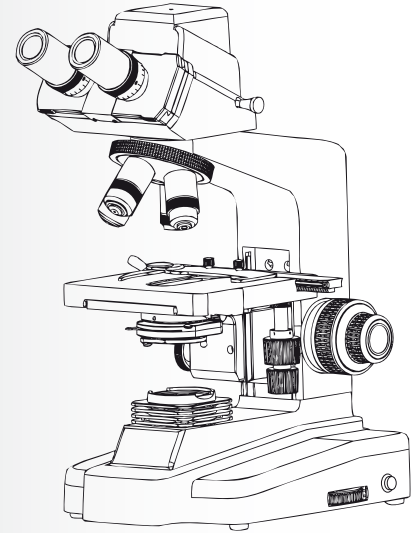

DMWB1

DMW143

simultaneously!

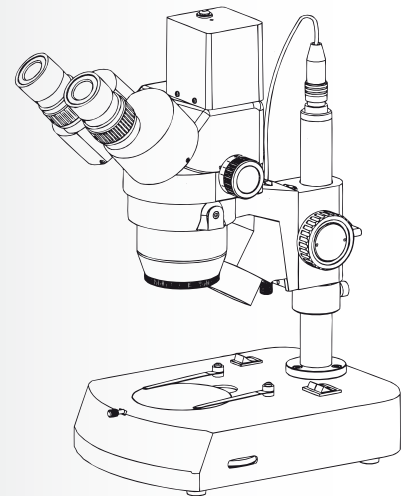
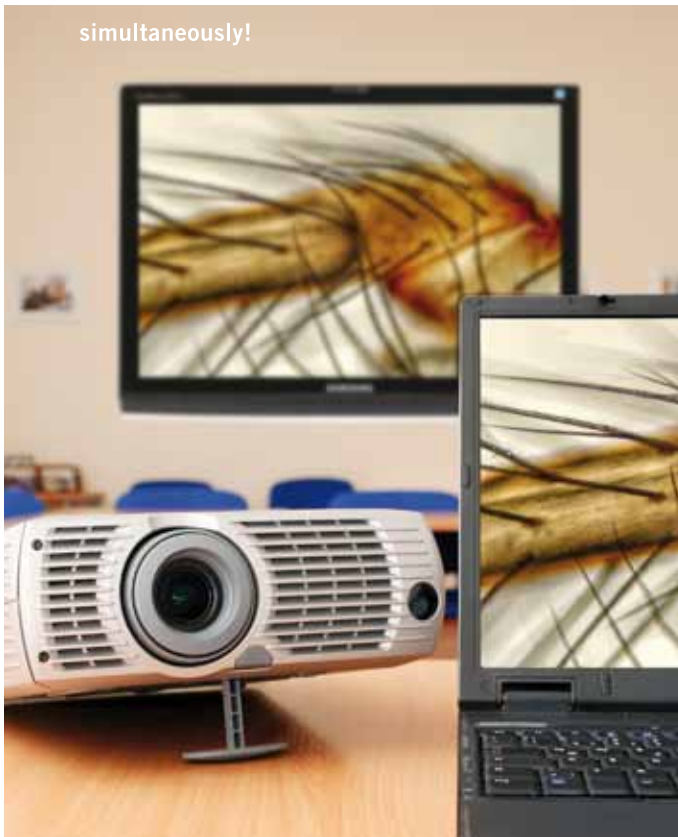

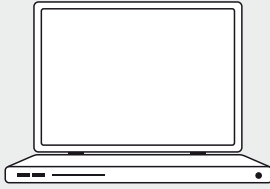

USB



Computer

Through the **USB 2.0** cable you can connect the **digital microscope** directly to your computer. By using the Motic Images Plus 2.0 Software, you can capture images, perform measurements and create video's, with just a few mouse clicks!

The **Motic Images Plus 2.0** is a complete analysing software, which allows you to get the maximum information from the image and use all kinds of image enhancement tools to prepare your picture for reports and presentations.

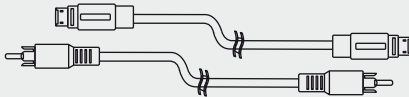

S-Video / RCA



Projector/Beamer

Connect the **digital microscope** directly to your projector/beamer with the **RCA or S-video cable**, in order to share your images with a larger audience. Even when the images are enlarged by the projector, the **digital microscopes** will ensure that crisp clear images are being displayed.

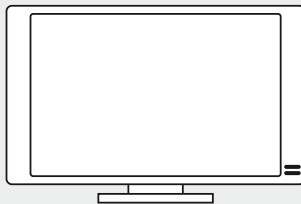

S-Video / RCA



TV Monitor

Use the **S-Video or RCA output** of the **digital microscope** to connect it directly to the TV monitor.

With a resolution of **550 TV lines**, even the finest details will be displayed.



Motic Images Plus 2.0

Sophisticated Image Analysis Software

The multi language image analysis software, **Motic Images Plus 2.0**, is your entry ticket to the digital world of microscopy.

Many years ago this software was introduced as a “basic” software for capturing images and for storing them in a digital format. Nowadays the **Motic Images Plus 2.0** is far from “basic”. With the help of many **Motic Digital Microscope** users around the world it has become **highly sophisticated image analysis software** with the following main functions:

Capture

Auto Capture

Video recording

Measurements

Automated counting

Creating reports

Image comparison

Amalgamation

At the present time we are still in close contact with many users of our software. Approximately each 6 months a new up-date of the **Motic Images Plus 2.0**, can be downloaded on our website. Once you have purchased a digital microscope you can get **unlimited FREE up-dates**.

Besides the software itself, we also put a lot of effort into making the digital microscopes compatible with different types of Operating systems, and of course the new releases of each Operating System. At present our digital microscopes are able to work with Windows (XP, Vista and 7), MAC and LINUX.

In case you would like to use a different Image analysis program with the digital microscope cameras, you can run most cameras by using the TWAIN driver or the DirectShow device.

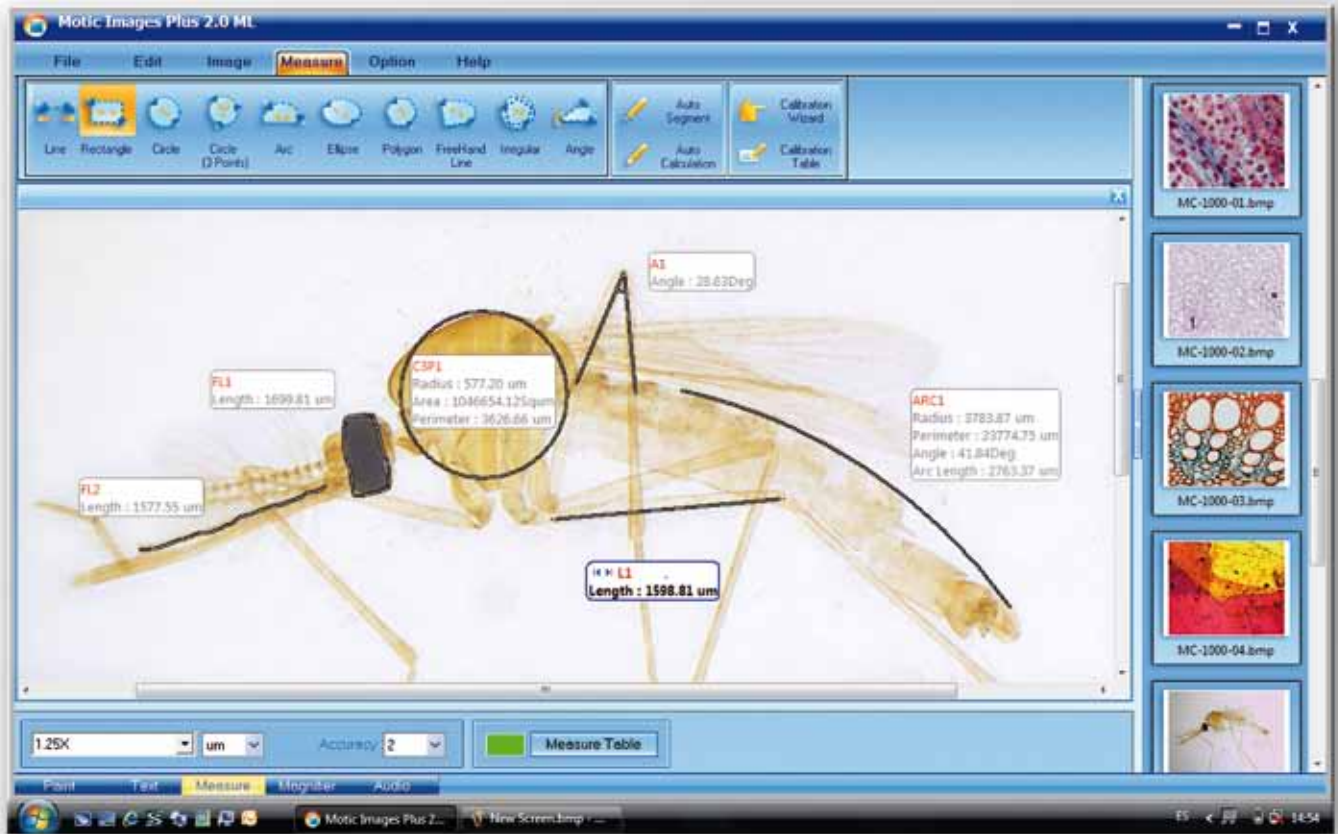

Motic Images Plus 2.0 ML - Measures

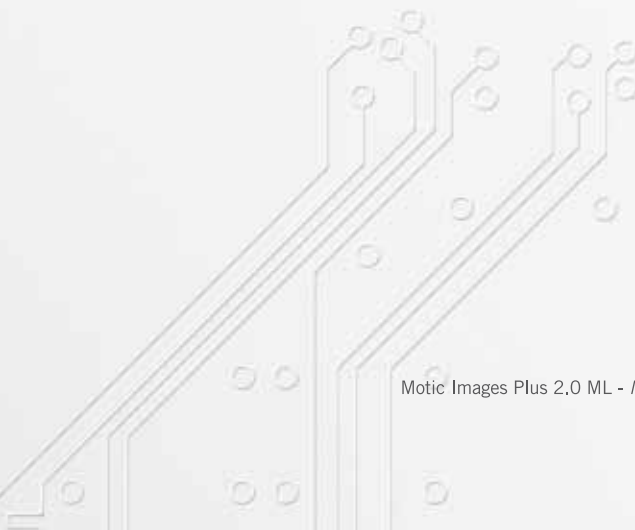

Motic Images Plus 2.0 ML - MI Device

